

# INDEX

ITEM	CONTENTS	SYMBOL	PAGE
Chip Bead	Multilayer (Ferrite)	SB	1
		GB	
		PB	
		UP	
		NB	
	Surface Mount	FB	25
	EMI PC	SBC	29
	Data Line	SBCB	33
	Surface Mount Tip / Ring Filters	CECRF	36
Chip Inductor	Multilayer (Ferrite)	CL	38
	Wound (Ferrite)	NL	47
		NLC	59
	High Frequency	Multilayer (Ceramic)	CLH
Wound (Ceramic)		LCN	78
Power Inductor	Non-Shielding	STD	98
		SSL	101
		SSL HC	112
		SCD	117
	Shielding	SCDS	128
		SDS	138
		SDT	145
		SLF	149
Transformers	EMI Filter Common Mode Choke		157
EMI Inductor	EMC Data Line Filter	SBCB	160

# MULTILAYER FERRITE CHIP BEADS

CLS offers hundreds of multi-layered ferrite chip beads with various sizes, frequency characteristics, and a board range of impedance values to provide a powerful solutions for EMI problems.

Three formulas of ferrite comprise several types of EMI suppression chip beads that are classified into six categories- SB, GB, PB, UP, NB and BA series.

## Shapes and Dimensions

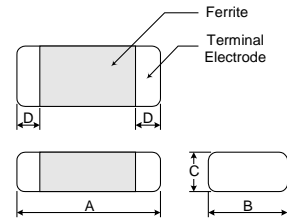

## Product Identification

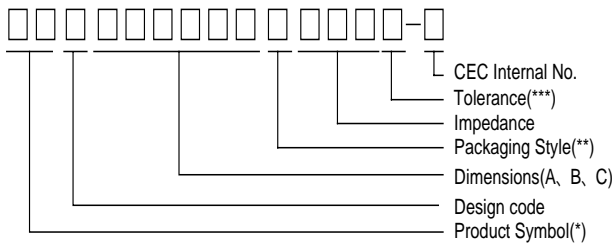

\* SB, PB, UP, NB, GB  
 \*\* T : Tape and Reel ; B : Bulk  
 \*\*\* Y = ± 25%      M = ± 20%

## Dimensions in mm

TYPE	A	B	C	D
①B100505	1.0±0.15	0.50±0.15	0.5±0.15	0.25±0.15
②B160808	1.6±0.20	0.80±0.15	0.8±0.15	0.3±0.2
②B201209	2.0±0.20	1.25±0.20	0.9±0.20	0.5±0.3
②B321611	3.2±0.20	1.60±0.20	1.1±0.20	0.5±0.3
③B321616	3.2±0.20	1.60±0.20	1.6±0.20	0.5±0.3
③B322513	3.2±0.20	2.50±0.20	1.3±0.20	0.5±0.3
④B451616	4.5±0.25	1.60±0.20	1.6±0.20	0.5±0.3
④B453215	4.5±0.25	3.20±0.20	1.5±0.20	0.5±0.3

① : S / P / N      ② : S / P / U / N / G  
 ③ : S / G          ④ : S / P / G

## SB series, for general use

### Features

- Standard type used to suppress lower-frequency, lower current signals.
- Impedance over a broad frequency range.
- Suitable for flow and reflow soldering
- Available in 8 sizes.

### Applications

- I/O ports, DC power lines, and Signal lines
- computer and peripheral products
- consumer electronic products

## Electrical Characteristics

Part Number	Test Frequency (MHz)	Impedance ( ±25%)	DC Resistance ( ) max.	Rated current (mA) max.
SBY100505T-060Y-S	100	6	0.05	500
SBY100505T-100Y-S	100	10	0.05	500
SBY100505T-400Y-S	100	40	0.30	300
SBY100505T-800Y-S	100	80	0.40	200
SBY100505T-121Y-S	100	120	0.50	200
SBY100505T-241Y-S	100	240	0.50	200
SBY100505T-481Y-S	100	480	0.80	100
SBY100505T-601Y-S	100	600	1.00	100

# MULTILAYER FERRITE CHIP BEADS

## Electrical Characteristics

Part Number	Test Frequency (MHz)	Impedance ( ±25%)	DC Resistance ( ) max.	Rated current (mA) max.
SBK160808T-110Y-S	100	11	0.05	500
SBK160808T-190Y-S	100	19	0.08	500
SBK160808T-300Y-S	100	30	0.10	400
SBK160808T-400Y-S	100	40	0.10	400
SBK160808T-600Y-S	100	60	0.10	300
SBK160808T-800Y-S	100	80	0.15	300
SBK160808T-121Y-S	100	120	0.25	300
SBK160808T-221Y-S	100	220	0.30	200
SBK160808T-301Y-S	100	300	0.40	200
SBK160808T-451Y-S	100	450	0.50	200
SBK160808T-601Y-S	100	600	0.50	200
SBK160808T-751Y-S	100	750	0.70	200
SBK160808T-102Y-S	100	1000	0.70	200
SBK160808T-152Y-S	100	1500	1.00	50
SBK160808T-222Y-S	100	2200	1.20	50
SBK160808T-272T-S	100	2700	1.30	50
SBY201209T-070Y-S	100	7	0.10	600
SBY201209T-090Y-S	100	9	0.10	600
SBY201209T-110Y-S	100	11	0.10	600
SBY201209T-170Y-S	100	17	0.10	600
SBY201209T-320Y-S	100	32	0.10	600
SBK201209T-600Y-S	100	60	0.15	500
SBK201209T-700Y-S	100	70	0.15	500
SBK201209T-800Y-S	100	80	0.15	500
SBK201209T-121Y-S	100	120	0.25	300
SBK201209T-151Y-S	100	150	0.25	300
SBK201209T-221Y-S	100	220	0.30	300
SBK201209T-301Y-S	100	300	0.30	300
SBK201209T-401Y-S	100	400	0.30	300
SBK201209T-501Y-S	100	500	0.40	300
SBK201209T-601Y-S	100	600	0.40	300
SBK201209T-751Y-S	100	750	0.50	200
SBK201209T-102Y-S	100	1000	0.50	200
SBK201209T-152Y-S	100	1500	0.60	200
SBK201209T-202Y-S	100	2000	0.80	100
SBK201209T-222Y-S	100	2200	1.00	100
SBK201209T-252Y-S	100	2500	1.0	100
SBK201209T-272Y-S	100	2700	1.5	100
SBY321611T-190Y-S	100	19	0.05	600
SBY321611T-260Y-S	100	26	0.05	600
SBY321611T-320Y-S	100	32	0.05	600
SBY321611T-500Y-S	100	50	0.10	500

# MULTILAYER FERRITE CHIP BEADS

## Electrical Characteristics

Part Number	Test Frequency (MHz)	Impedance ( ±25%)	DC Resistance ( ) max.	Rated current (mA) max.
SBY321611T-600Y-S	100	60	0.10	500
SBK321611T-700Y-S	100	70	0.10	500
SBK321611T-900Y-S	100	90	0.15	500
SBK321611T-121Y-S	100	120	0.15	500
SBK321611T-151Y-S	100	150	0.15	500
SBK321611T-201Y-S	100	200	0.20	400
SBK321611T-401Y-S	100	400	0.20	400
SBK321611T-501Y-S	100	500	0.20	400
SBK321611T-601Y-S	100	600	0.30	400
SBK321611T-102Y-S	50	1000	0.40	200
SBK321611T-122Y-S	50	1200	0.40	200
SBK321611T-152Y-S	50	1500	0.45	200
SBK321611T-202Y-S	30	2000	0.60	200
SBK321611T-272Y-S	30	2700	0.60	200
SBY321616T-250Y-S	100	25	0.10	500
SBY321616T-600Y-S	100	60	0.20	500
SBK321616T-700Y-S	100	70	0.20	500
SBY322513T-320Y-S	100	32	0.20	500
SBY322513T-600Y-S	100	60	0.20	500
SBY322513T-900Y-S	100	90	0.20	500
SBY451616T-500Y-S	100	50	0.20	600
SBY451616T-600Y-S	100	60	0.20	600
SBY451616T-800Y-S	100	80	0.20	600
SBY451616T-101Y-S	100	100	0.30	500
SBK451616T-151Y-S	100	150	0.30	500
SBK451616T-171Y-S	100	170	0.30	500
SBY453215T-700Y-S	100	70	0.30	500
SBY453215T-121Y-S	100	120	0.30	500

## Test Instruments : HP4291A Impedance / Material Analyzer

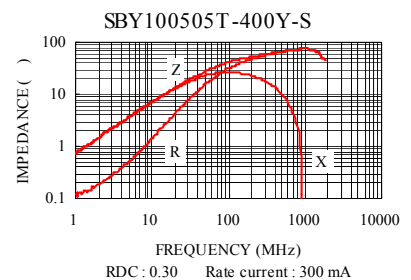
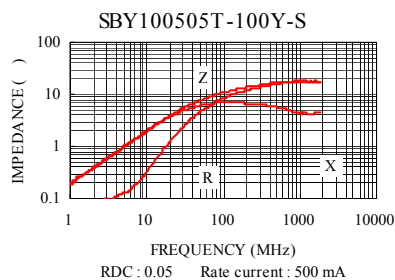
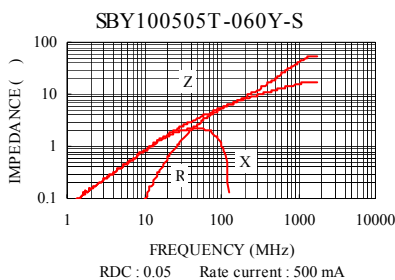

# MULTILAYER FERRITE CHIP BEADS

## Test Instruments : HP4291A Impedance / Material Analyzer

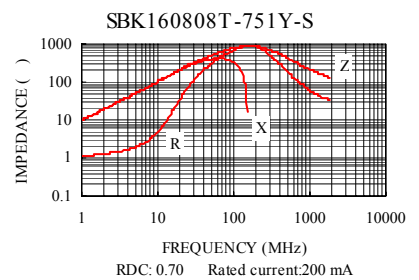
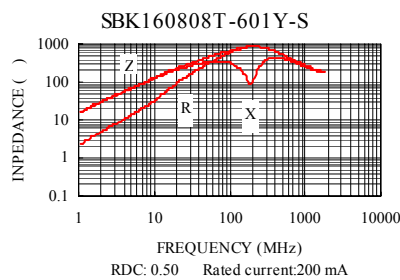
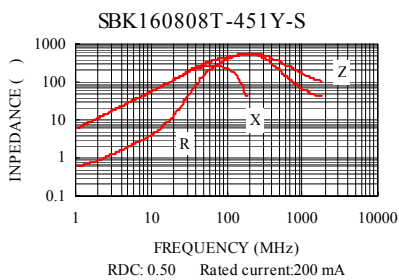
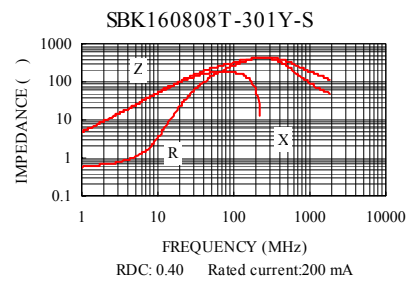
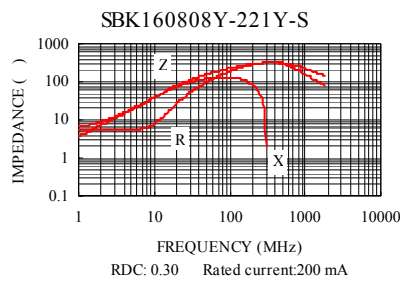
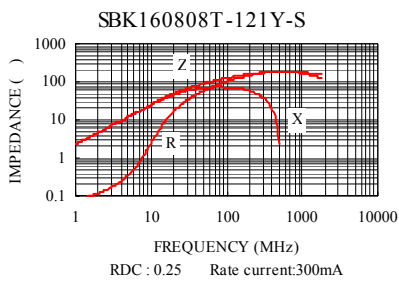
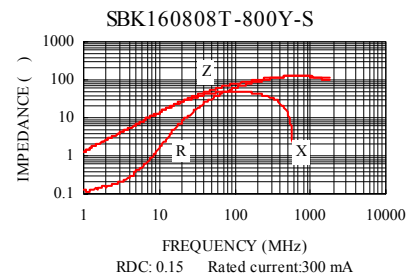
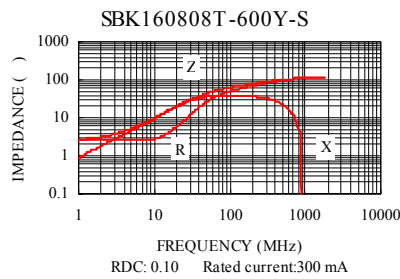
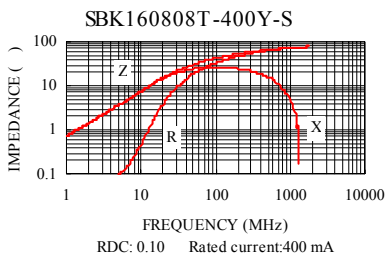
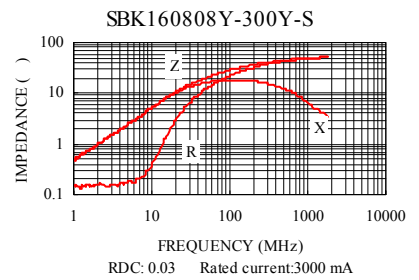
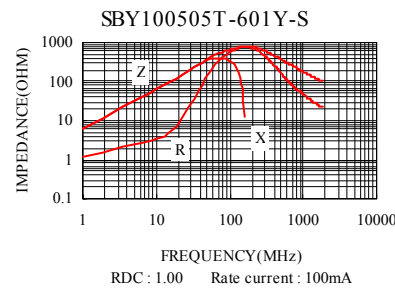
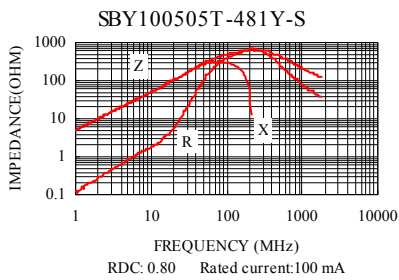
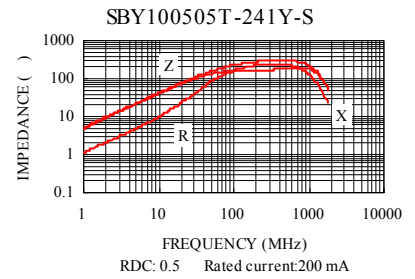
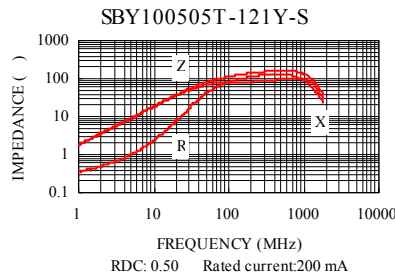
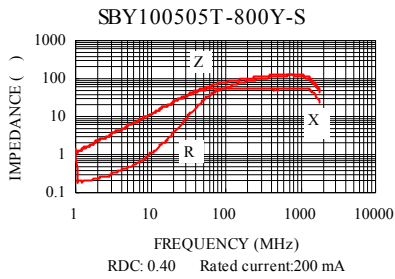

# MULTILAYER FERRITE CHIP BEADS

## Test Instruments : HP4291A Impedance / Material Analyzer

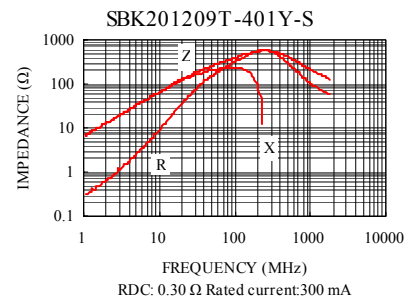
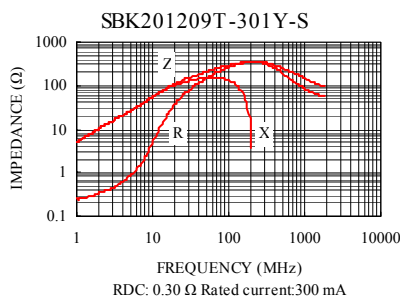
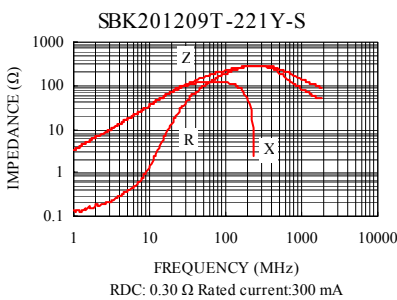
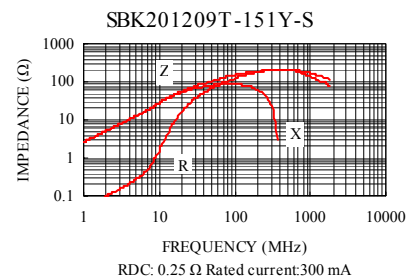
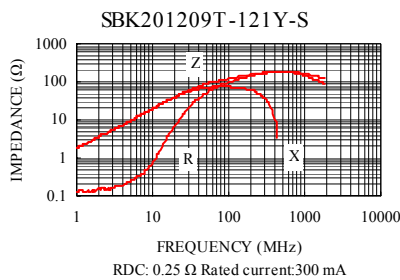
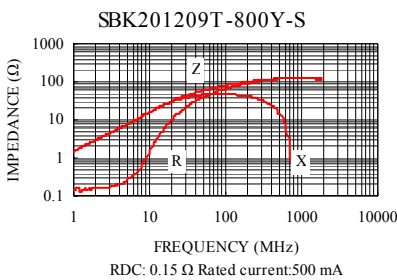
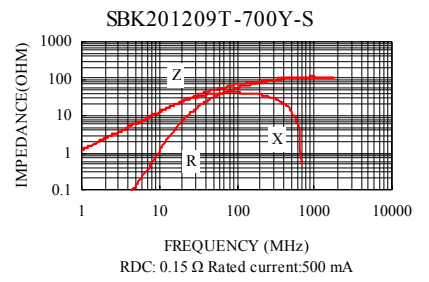
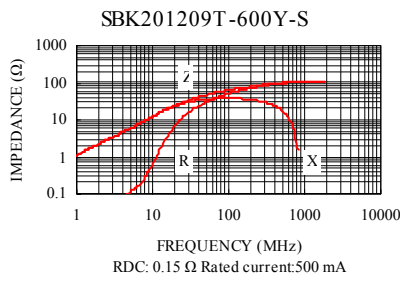
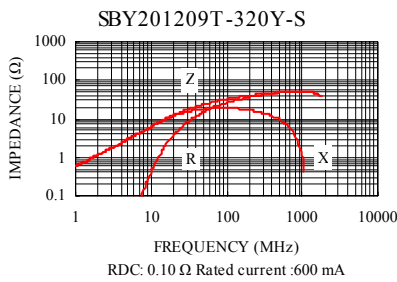
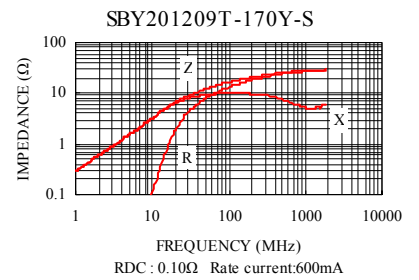
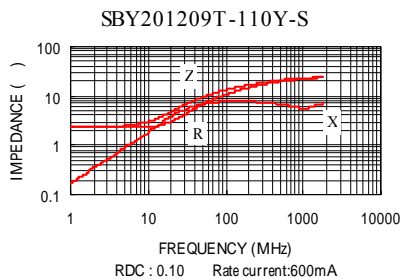
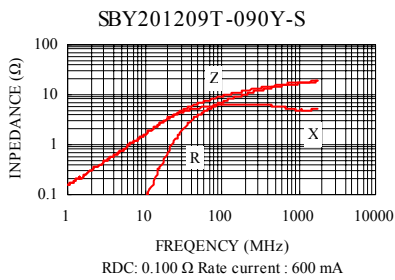
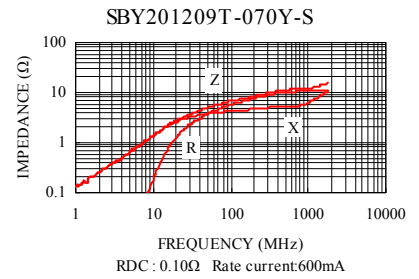
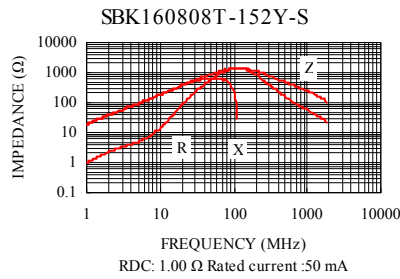
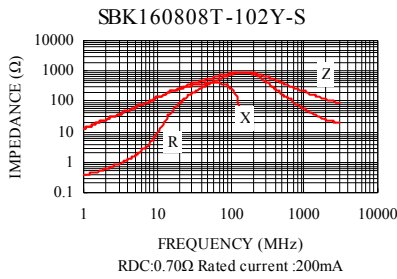

# MULTILAYER FERRITE CHIP BEADS

## Test Instruments : HP4291A Impedance / Material Analyzer

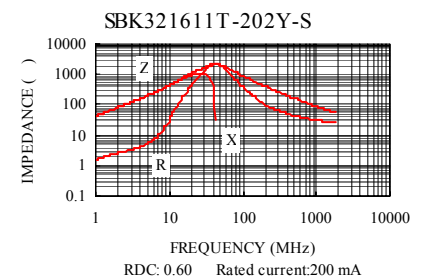
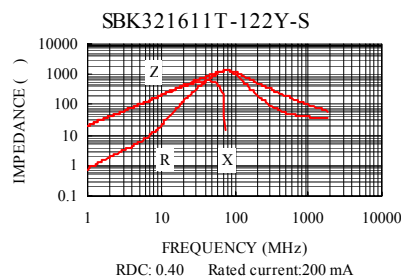
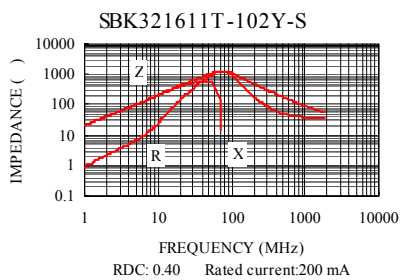
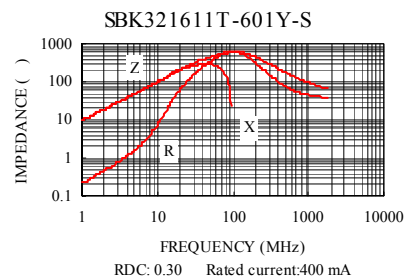
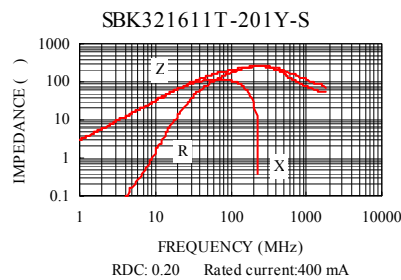
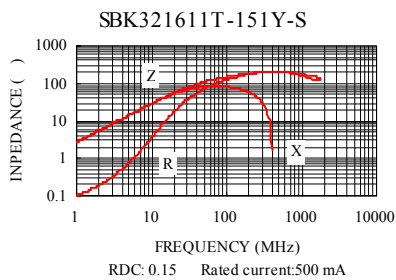
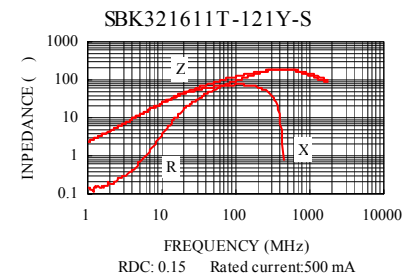
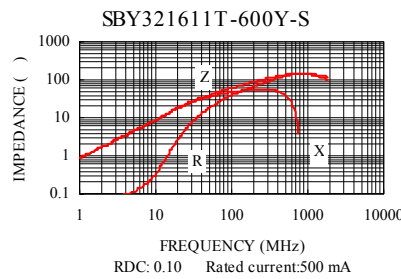
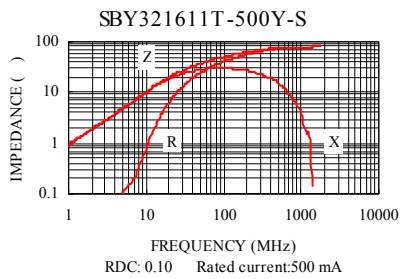
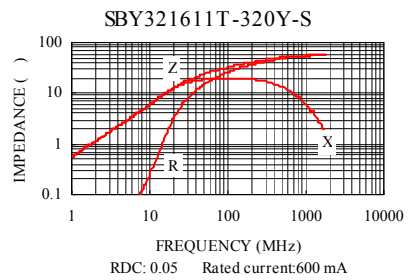
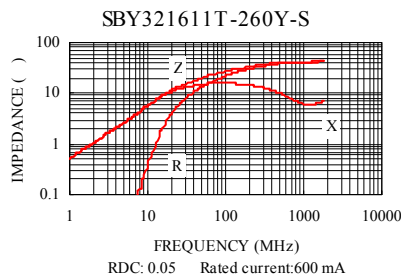
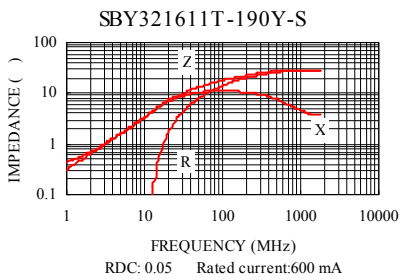
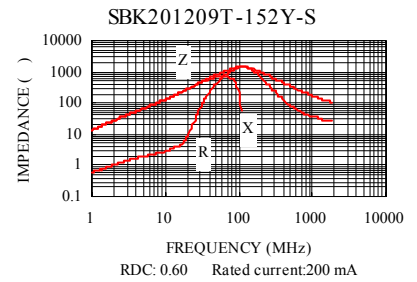
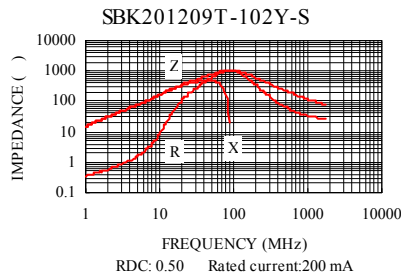
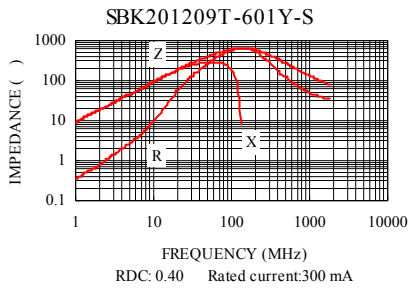

# MULTILAYER FERRITE CHIP BEADS

## Test Instruments : HP4291A Impedance / Material Analyzer

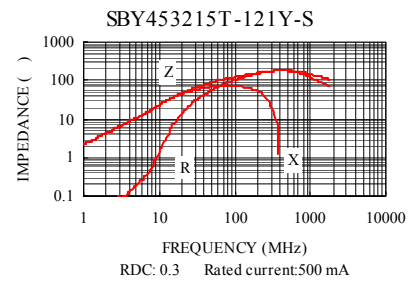
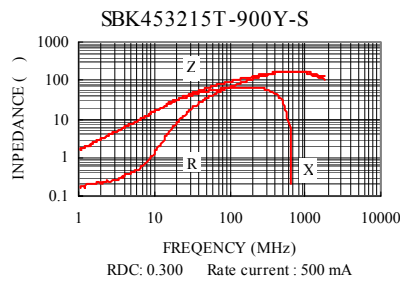
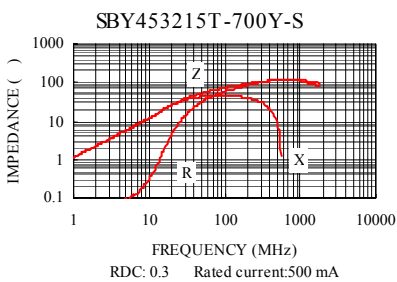
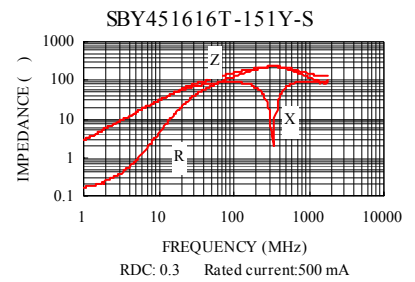
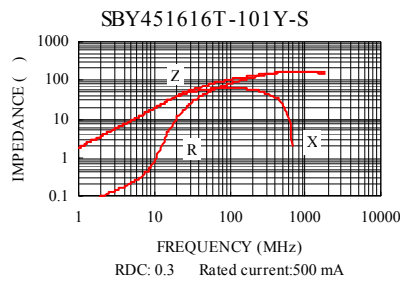
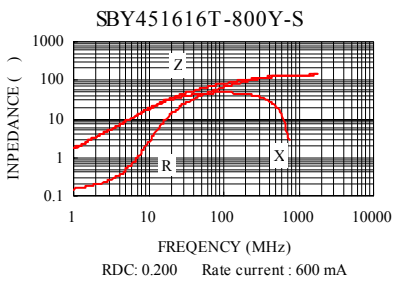
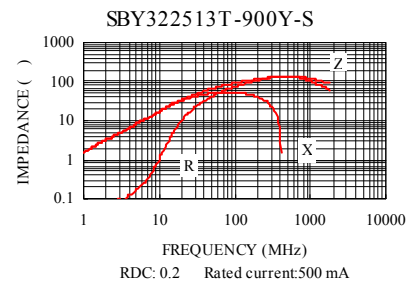
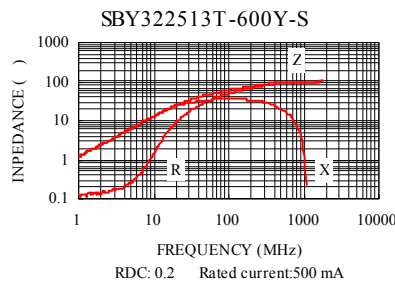
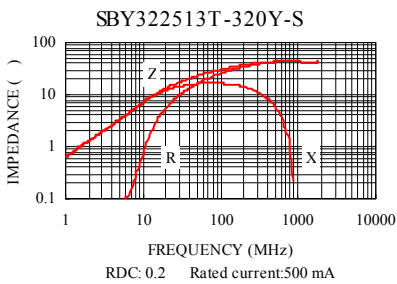
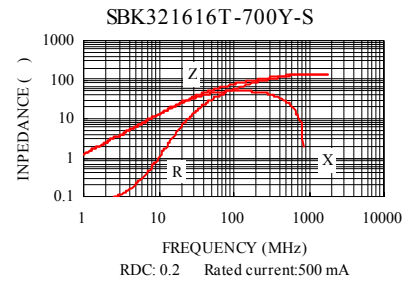
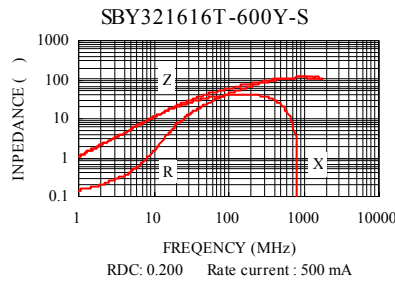
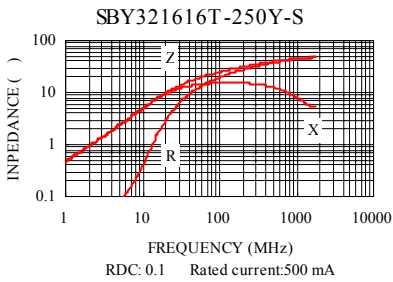



# MULTILAYER FERRITE CHIP BEADS / GB SERIES

## GB series, for mid current use

### Features

- This series exhibits a low DC resistance across a wide range of impedances.
- Low DC resistance characteristics make the chip beads suitable for use on signal lines handling larger currents.

### Applications

- Computers
- Modems
- CD-ROMs
- Hard Drives
- Televisions
- Wireless Device

### Electrical Characteristics

Part Number	Test Frequency (MHz)	Impedance ( ±25%)	D.C. Resistance ( ) max.	Rated current (mA) max.
GBK160808T-110Y-S	100	11	0.03	1000
GBK160808T-190Y-S	100	19	0.05	1000
GBK160808T-300Y-S	100	30	0.06	800
GBK160808T-400Y-S	100	40	0.06	800
GBK160808T-600Y-S	100	60	0.06	600
GBK160808T-800Y-S	100	80	0.10	600
GBK160808T-121Y-S	100	120	0.15	600
GBK160808T-221Y-S	100	220	0.18	400
GBK160808T-301Y-S	100	300	0.25	400
GBK160808T-451Y-S	100	450	0.30	400
GBK160808T-601Y-S	100	600	0.30	400
GBK160808T-751Y-S	100	750	0.45	300
GBK160808T-102Y-S	100	1000	0.45	300
GBY201209T-070Y-S	100	7	0.06	1000
GBY201209T-090Y-S	100	9	0.06	1000
GBY201209T-110Y-S	100	11	0.06	1000
GBY201209T-170Y-S	100	17	0.06	1000
GBY201209T-320Y-S	100	32	0.06	1000
GBK201209T-600Y-S	100	60	0.10	800
GBK201209T-700Y-S	100	70	0.10	800
GBK201209T-800Y-S	100	80	0.10	800
GBK201209T-121Y-S	100	120	0.15	600
GBK201209T-151Y-S	100	150	0.15	600
GBK201209T-221Y-S	100	220	0.18	600
GBK201209T-301Y-S	100	300	0.18	600
GBK201209T-401Y-S	100	400	0.18	600
GBK201209T-501Y-S	100	500	0.25	500
GBK201209T-601Y-S	100	600	0.25	500
GBK201209T-751Y-S	100	750	0.30	400
GBK201209T-102Y-S	100	1000	0.30	400
GBK201209T-152Y-S	100	1500	0.40	300
GBK201209T-202Y-S	100	2000	0.55	200

# MULTILAYER FERRITE CHIP BEADS / GB SERIES

## Electrical Characteristics

Part Number	Test Frequency (MHz)	Impedance ( ±25%)	D.C. Resistance ( ) max.	Rated current (mA) max.
GBY321611T-190Y-S	100	19	0.03	1000
GBY321611T-260Y-S	100	26	0.03	1000
GBY321611T-320Y-S	100	32	0.03	1000
GBY321611T-500Y-S	100	50	0.06	800
GBY321611T-600Y-S	100	60	0.06	800
GBK321611T-700Y-S	100	70	0.06	800
GBK321611T-900Y-S	100	90	0.10	800
GBK321611T-121Y-S	100	120	0.10	800
GBK321611T-151Y-S	100	150	0.10	800
GBK321611T-201Y-S	100	200	0.15	600
GBK321611T-401Y-S	100	400	0.15	600
GBK321611T-501Y-S	100	500	0.15	600
GBK321611T-601Y-S	100	600	0.20	500
GBK321611T-102Y-S	50	1000	0.25	400
GBK321611T-122Y-S	50	1200	0.25	400
GBK321611T-202Y-S	30	2000	0.35	400
GBY321616T-250Y-S	100	25	0.10	1000
GBY321616T-600Y-S	100	60	0.10	1000
GBK321616T-700Y-S	100	70	0.10	1000
GBY322513T-320Y-S	100	32	0.10	1000
GBY322513T-600Y-S	100	60	0.10	1000
GBY322513T-900Y-S	100	90	0.10	1000
GBY451616T-500Y-S	100	50	0.10	1000
GBY451616T-600Y-S	100	60	0.10	1000
GBY451616T-800Y-S	100	80	0.10	1000
GBY451616T-101Y-S	100	100	0.18	800
GBK451616T-151Y-S	100	150	0.18	800
GBK451616T-171Y-S	100	170	0.18	800
GBY453215T-700Y-S	100	70	0.18	800
GBY453215T-121Y-S	100	120	0.18	800

## Test Instruments : HP4291A Impedance / Material Analyzer

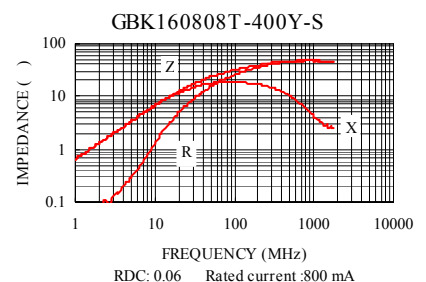
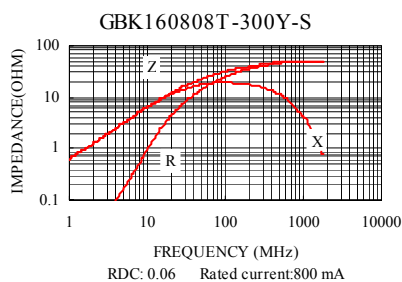
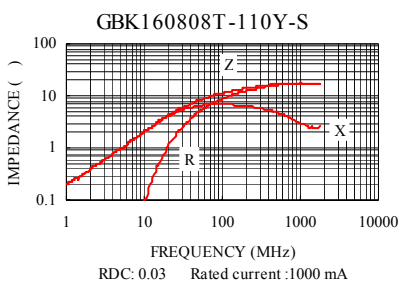

# MULTILAYER FERRITE CHIP BEADS / GB SERIES

## Test Instruments : HP4291A Impedance / Material Analyzer

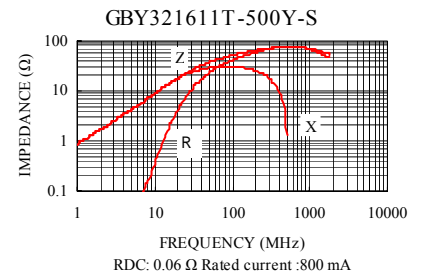
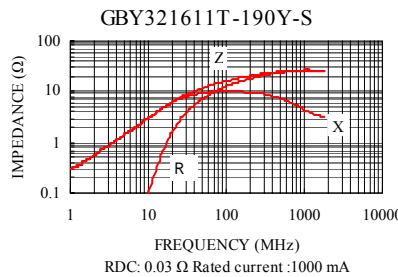
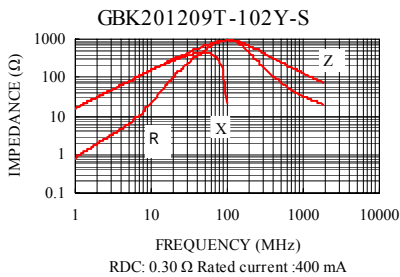
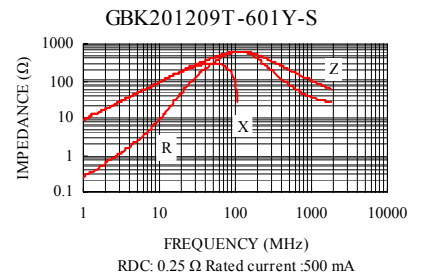
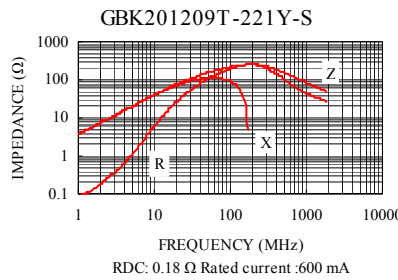
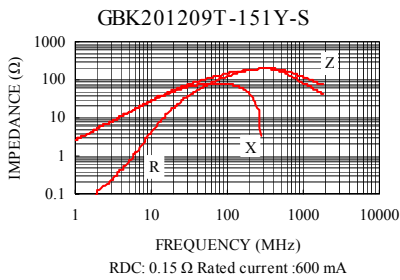
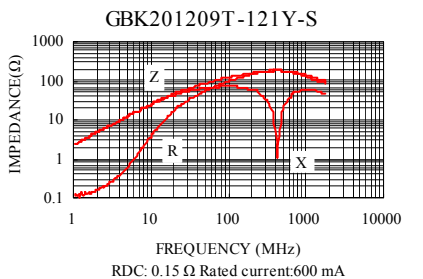
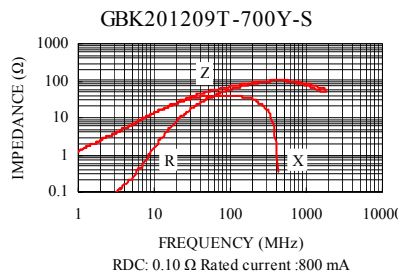
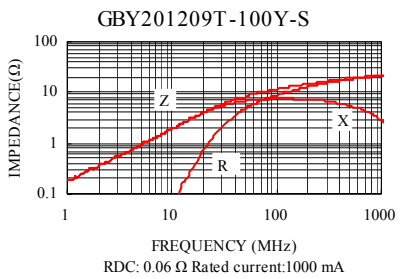
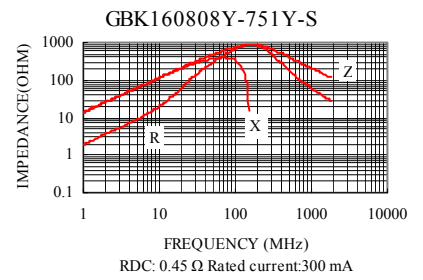
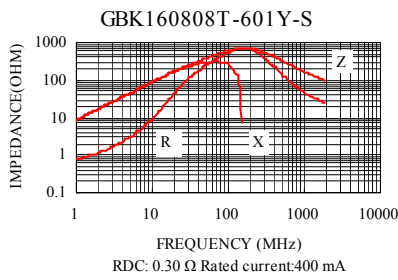
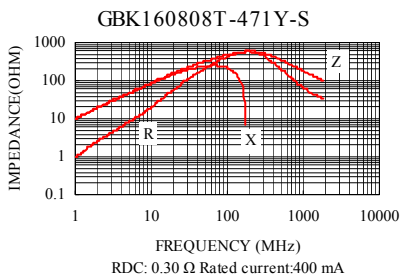
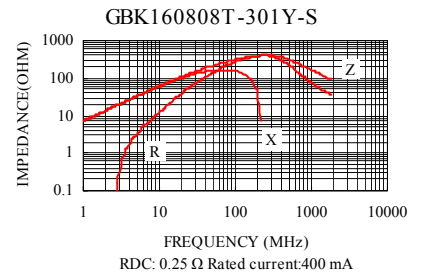
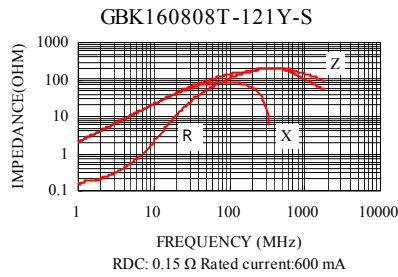
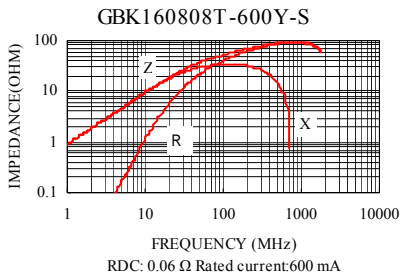

# MULTILAYER FERRITE CHIP BEADS / GB SERIES

## Test Instruments : HP4291A Impedance / Material Analyzer

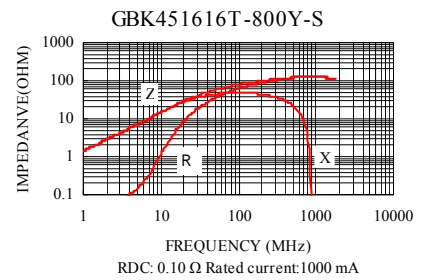
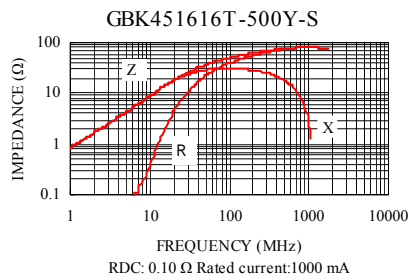
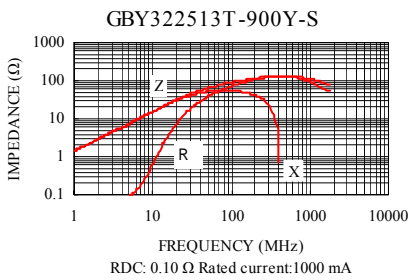
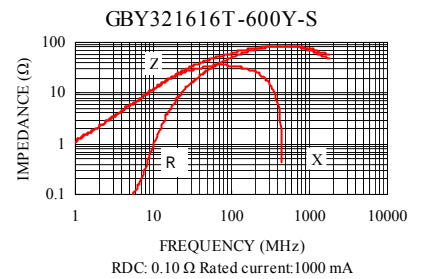
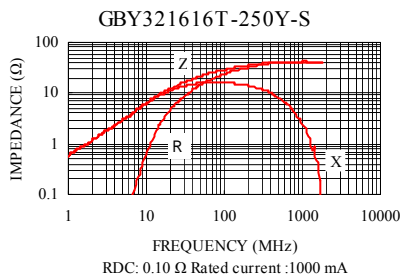
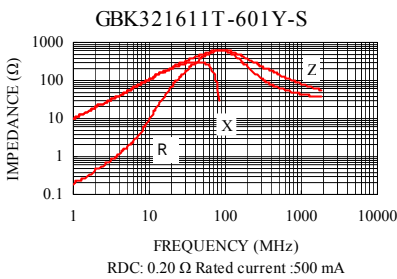
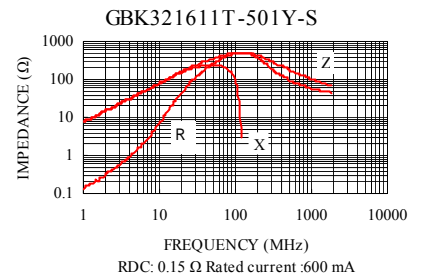
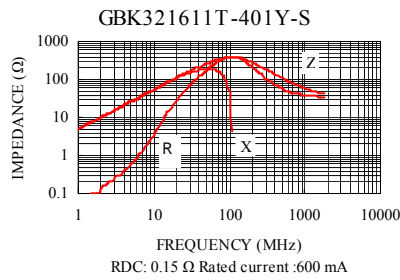
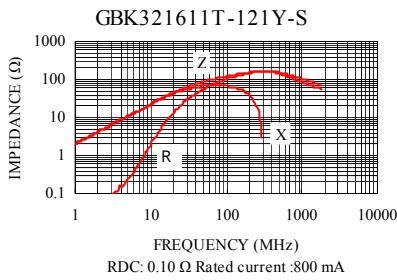

# MULTILAYER FERRITE CHIP BEADS / PB SERIES

## PB series, for high current use

### Features

- Suitable for high current applications
- Small package size—EIA STD 0402/0603/0805/1206/1806 and 1812
- Nickel barrier terminations provide excellent solder heat resistance
- Current rating up to 6 AMPS ( max ) ( high current handling capacity)
- Low DCR
- Suitable for flow and reflow soldering
- Available in 6 sizes

### Applications

- High current DC power lines for USB interface circuitry, personal computers, electronic games, hard disk drives, and other general electronic equipment.

### Electrical Characteristics

Part Number	Test Frequency (MHz)	Impedance ( $\pm 25\%$ )	D.C. Resistance ( ) max.	Rated current (mA) max.
PBY100505T-100Y-S	100	10	0.03	1000
PBY160808T-110Y-S	100	11	0.02	4000
PBY160808T-250Y-S	100	25	0.03	3000
PBY160808T-400Y-S	100	40	0.035	3000
PBY160808T-600Y-S	100	60	0.04	3000
PBY160808T-121Y-S	100	120	0.08	2500
PBY160808T-301Y-S	100	300	0.10	2000
PBY160808T-501Y-S	100	500	0.15	1500
PBY160808T-601Y-S	100	600	0.20	1000
PBY160808T-102Y-S	100	1000	0.25	800
PBY201209T-110Y-S	100	11	0.01	6000
PBY201209T-170Y-S	100	17	0.02	5000
PBY201209T-300Y-S	100	30	0.02	4000
PBY201209T-500Y-S	100	50	0.025	3000
PBY201209T-600Y-S	100	60	0.03	3000
PBY201209T-800Y-S	100	80	0.04	3000
PBY201209T-121Y-S	100	120	0.04	3000
PBY201209T-201Y-S	100	200	0.05	2500
PBY201209T-301Y-S	100	300	0.08	2000
PBY201209T-601Y-S	100	600	0.10	2000
PBY201209T-102Y-S	100	1000	0.12	1500
PBY321611T-190Y-S	100	19	0.015	6000
PBY321611T-320Y-S	100	32	0.015	4000
PBY321611T-500Y-S	100	50	0.02	4000
PBY321611T-800Y-S	100	80	0.025	3000
PBY321611T-101Y-S	100	100	0.03	2500
PBY321611T-301Y-S	100	300	0.06	2000

# MULTILAYER FERRITE CHIP BEADS / PB SERIES

## Electrical Characteristics

Part Number	Test Frequency (MHz)	Impedance ( ±25%)	D.C. Resistance ( ) max.	Rated current (mA) max.
PBY321611T-601Y-S	100	600	0.10	1800
PBY321611T-102Y-S	50	1000	0.15	1200
PBY321611T-122Y-S	50	1200	0.18	1000
PBY321611T-152Y-S	50	1500	0.20	800
PBY322513T-600Y-S	100	60	0.025	4000
PBY322513T-900Y-S	100	90	0.025	3000
PBY451616T-500Y-S	100	50	0.020	6000
PBY451616T-600Y-S	100	60	0.020	5000
PBY451616T-800Y-S	100	80	0.025	4000
PBY451616T-151Y-S	100	150	0.100	2000
PBY453215T-700Y-S	100	70	0.03	6000
PBY453215T-121Y-S	100	120	0.03	4000

## Test Instruments : HP4291A Impedance / Material Analyzer

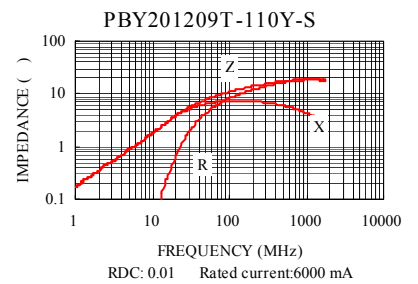
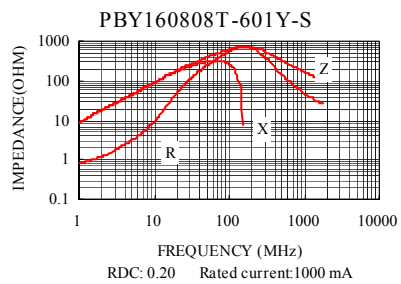
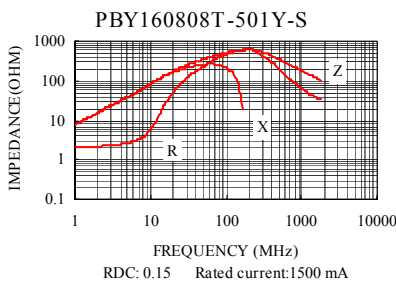
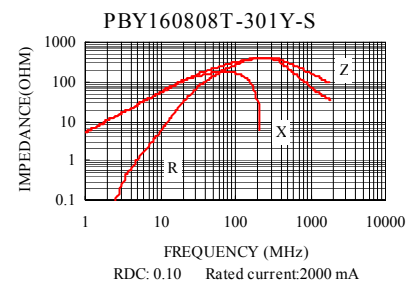
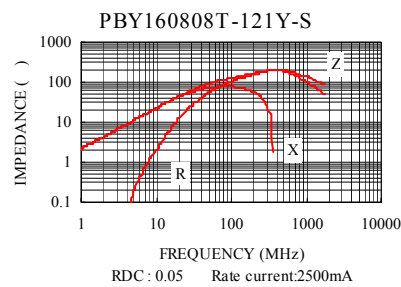
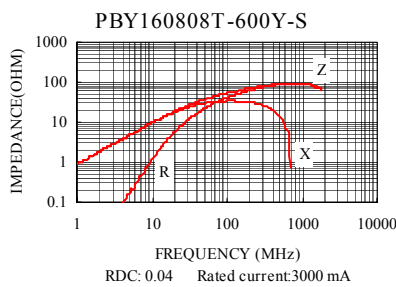
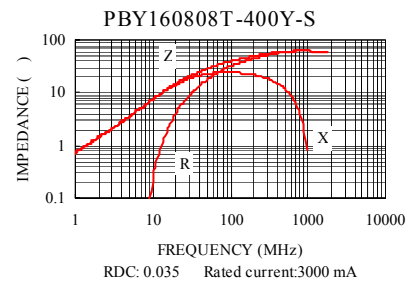
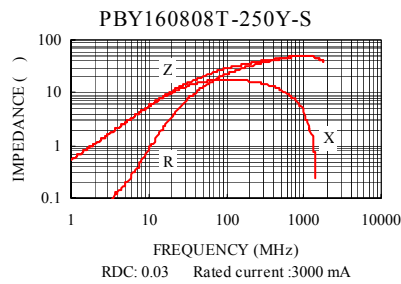
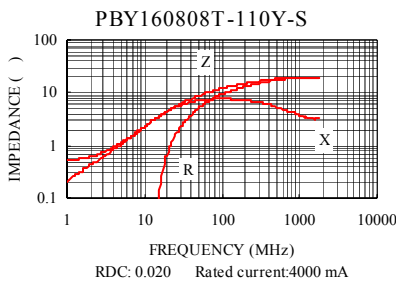

# MULTILAYER FERRITE CHIP BEADS / PB SERIES

## Test Instruments : HP4291A Impedance / Material Analyzer

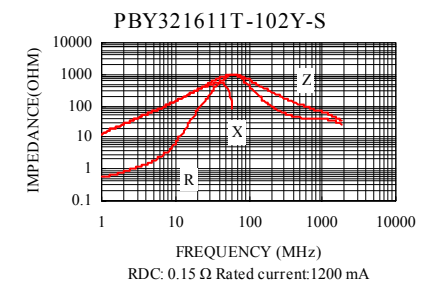
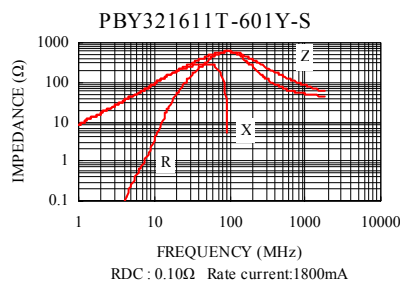
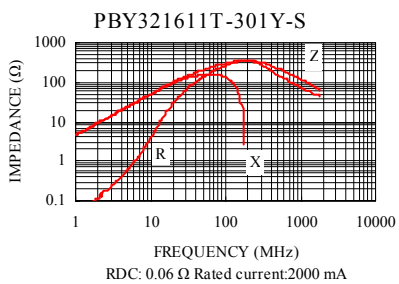
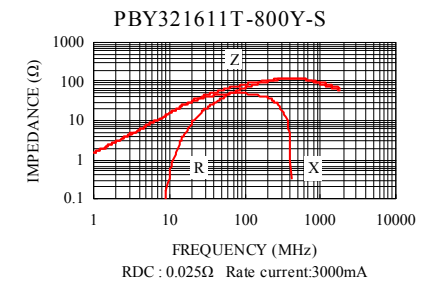
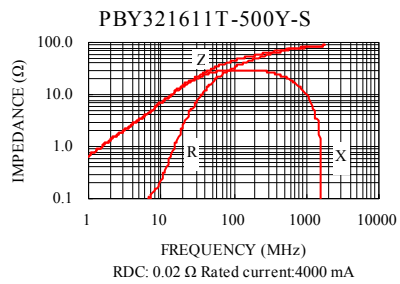
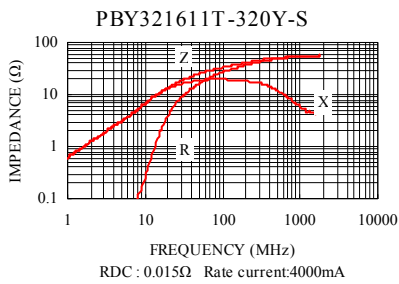
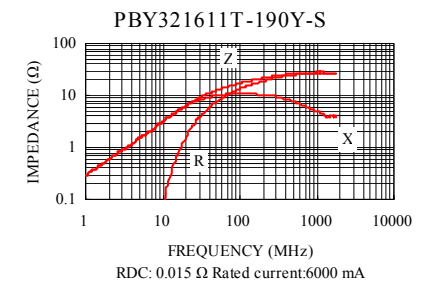
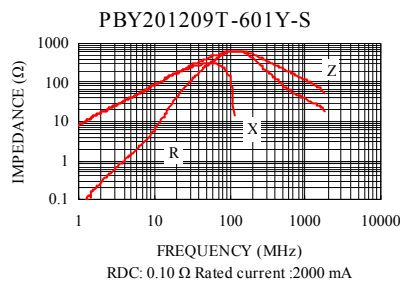
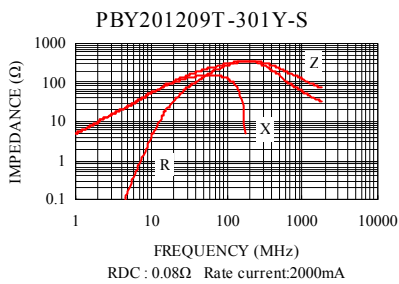
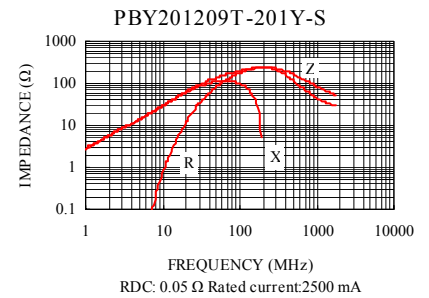
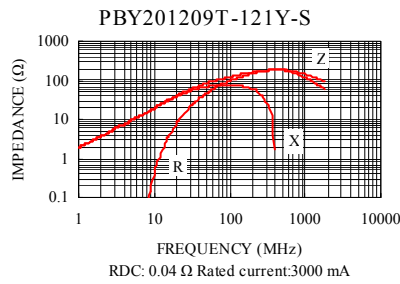
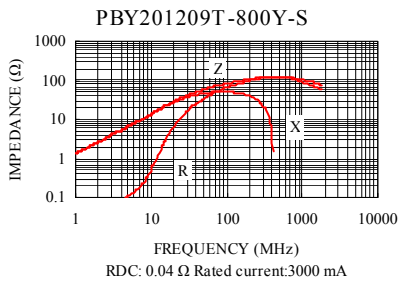
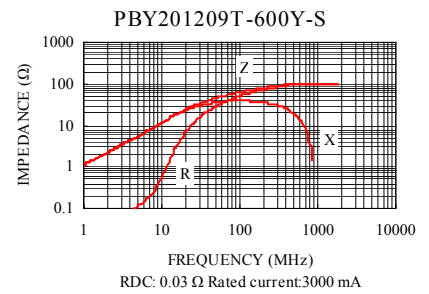
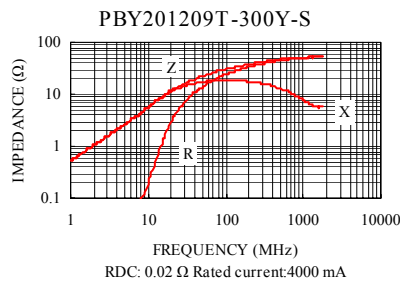
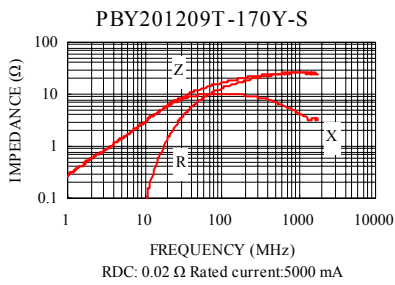

# MULTILAYER FERRITE CHIP BEADS / PB SERIES

## Test Instruments : HP4291A Impedance / Material Analyzer

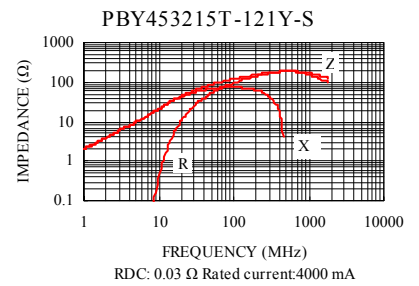
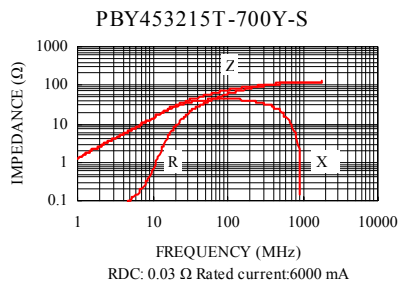
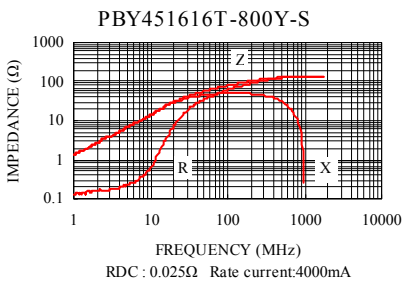
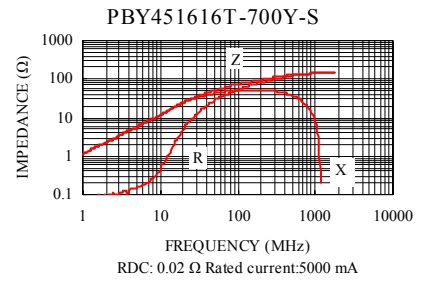
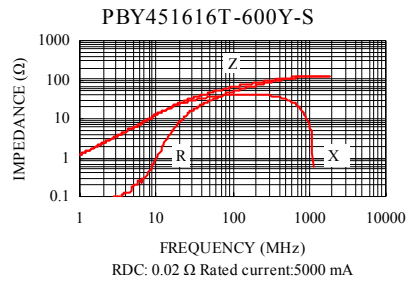
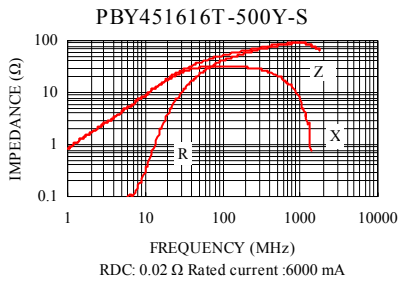



# MULTILAYER FERRITE CHIP BEADS / UPB SERIES

## UPB series, for ultra high current use

### Features

- High current performance.
- Low D.C. resistance minute mΩ typically.
- Impedance character of broad frequency.

### Applications

- Preventing of electronics magnet interference in power line of PC, Printer, & CD ROM.
- High frequency filtering of medium speed clocks and video signals.

### Electrical Characteristics

Part Number	Test Frequency (MHz)	Impedance (Ω)	D.C. Resistance (Ω) max.	Rated current (mA) max.
UPB160808T-250Y-S	100	25	0.015	4500
UPB160808T-300Y-S	100	30	0.015	4500
UPB201209T-400Y-S	100	40	0.015	5000
UPB201209T-500Y-S	100	50	0.015	5000
UPB201209T-600Y-S	100	60	0.020	4500
UPB321611T-600Y-S	100	60	0.012	6000
UPB321611T-800Y-S	100	80	0.012	6000
UPB321611T-101Y-S	100	100	0.012	6000
UPB321611T-121Y-S	100	120	0.012	6000
UPB321611T-151Y-S	100	150	0.020	4500

### Test Instruments : HP4291A Impedance / Material Analyzer

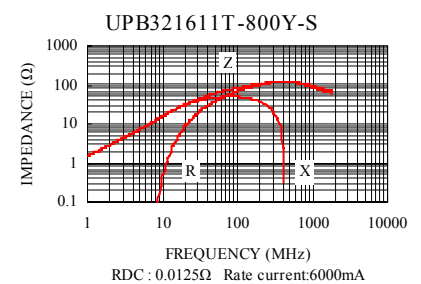
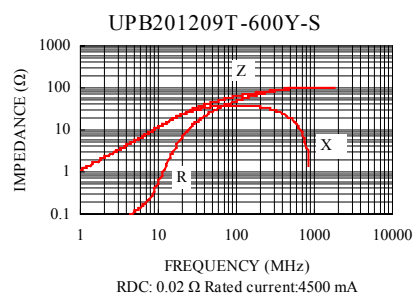
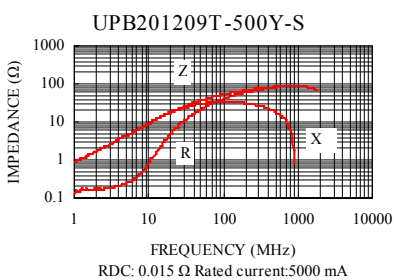
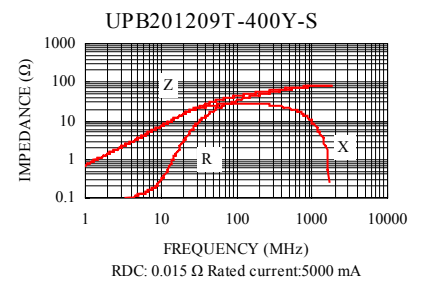
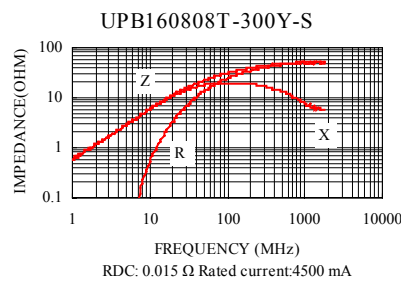
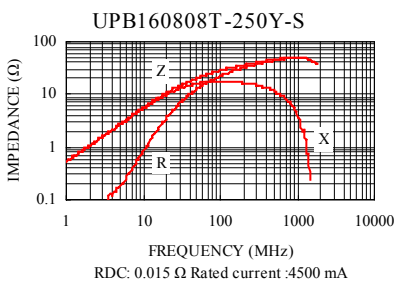

# MULTILAYER FERRITE CHIP BEADS / NB SERIES

**NB series, for high speed signals use**

## Features

- Exhibiting high impedance with sharp increase at high speed signal frequencies with minimal diminishing the desired wave form.
- Suitable for flow and reflow soldering
- Available in 4 sizes

## Applications

- High speed circuits for computer & peripheral equipments and communication devices.
- Cellular phone
- Suitable for circuits with unstable ground

## Electrical Characteristics

Part Number	Test Frequency (MHz)	Impedance ( ±25%)	D.C. Resistance ( ) max.	Rated current (mA) max.
NBQ100505T-060Y-S	100	6	0.10	300
NBQ100505T-100Y-S	100	10	0.20	200
NBQ100505T-400Y-S	100	40	0.40	150
NBQ100505T-800Y-S	100	80	0.60	100
NBQ100505T-121Y-S	100	120	0.80	50
NBQ160808T-060Y-S	100	6	0.05	500
NBQ160808T-100Y-S	100	10	0.07	400
NBQ160808T-400Y-S	100	40	0.30	300
NBQ160808T-600Y-S	100	60	0.30	300
NBQ160808T-800Y-S	100	80	0.40	300
NBQ160808T-121Y-S	100	120	0.40	300
NBQ160808T-241Y-S	100	240	0.40	200
NBQ160808T-301Y-S	100	300	0.50	200
NBQ160808T-481Y-S	100	480	0.60	150
NBQ160808T-601Y-S	100	600	0.60	100
NBQ160808T-102Y-S	100	1000	0.70	100
NBQ160808T-122Y-S	100	1200	0.70	100
NBQ160808T-152Y-S	100	1500	0.80	100
NBQ160808T-182Y-S	100	1800	0.95	100
NBQ201209T-060Y-S	100	6	0.07	800
NBQ201209T-110Y-S	100	11	0.10	700
NBQ201209T-260Y-S	100	26	0.20	600
NBQ201209T-320Y-S	100	32	0.20	600
NBQ201209T-600Y-S	100	60	0.30	500
NBQ201209T-750Y-S	100	75	0.30	500
NBQ201209T-900Y-S	100	90	0.30	500
NBQ201209T-121Y-S	100	120	0.40	400
NBQ201209T-151Y-S	100	150	0.40	400
NBQ201209T-171Y-S	100	170	0.50	400
NBQ201209T-221Y-S	100	220	0.50	300
NBQ201209T-301Y-S	100	300	0.50	300

# MULTILAYER FERRITE CHIP BEADS / NB SERIES

## Electrical Characteristics

Part Number	Test Frequency (MHz)	Impedance ( ±25%)	D.C. Resistance ( ) max.	Rated current (mA) max.
NBQ201209T-401Y-S	100	400	0.50	300
NBQ201209T-501Y-S	100	500	0.50	200
NBQ201209T-601Y-S	100	600	0.50	200
NBQ201209T-102Y-S	100	1000	0.60	100
NBQ201209T-122Y-S	100	1200	0.70	100
NBQ201209T-152Y-S	100	1500	0.70	100
NBQ201209T-222Y-S	100	2200	0.75	100
NBQ201209T-272Y-S	100	2700	0.85	100
NBQ321611T-320Y-S	100	32	0.20	600
NBQ321611T-600Y-S	100	60	0.30	500
NBQ321611T-800Y-S	100	80	0.30	500
NBQ321611T-900Y-S	100	90	0.30	500
NBQ321611T-121Y-S	100	120	0.40	400
NBQ321611T-151Y-S	100	150	0.40	400
NBQ321611T-201Y-S	100	200	0.50	300
NBQ321611T-221Y-S	100	220	0.50	300
NBQ321611T-351Y-S	100	350	0.60	300
NBQ321611T-401Y-S	100	400	0.60	300
NBQ321611T-601Y-S	100	600	0.80	300
NBQ321611T-122Y-S	100	1200	1.00	200
NBQ321611T-152Y-S	100	1500	1.20	150

## Test Instruments : HP4291A Impedance / Material Analyzer

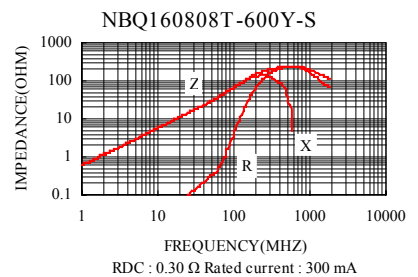
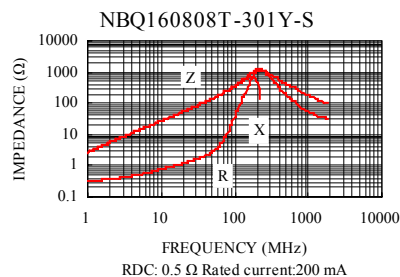
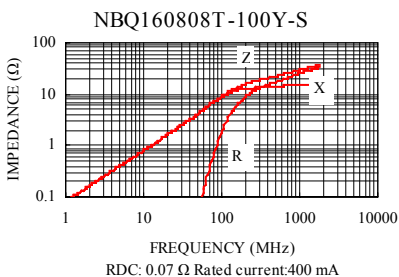
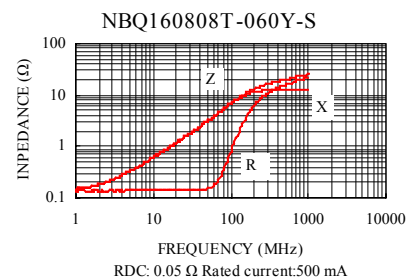
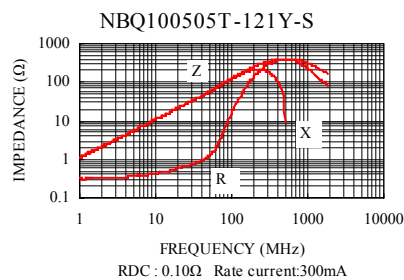
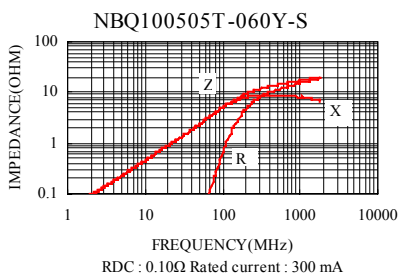



# MULTILAYER FERRITE CHIP BEADS / NB SERIES

Test Instruments : HP4291A Impedance / Material Analyzer

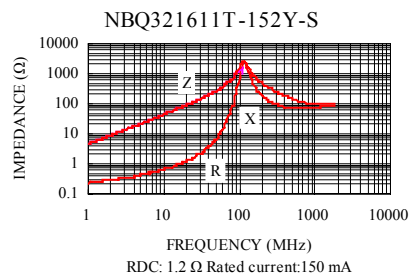
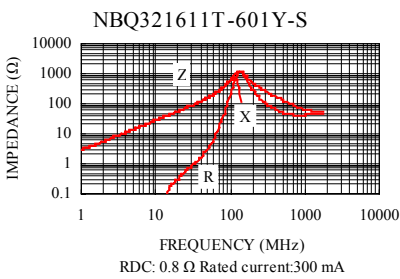
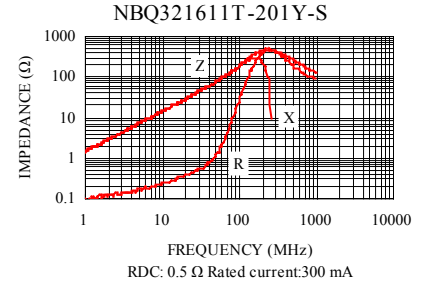
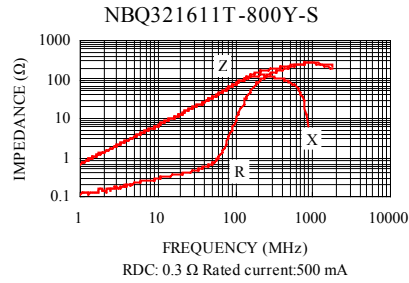
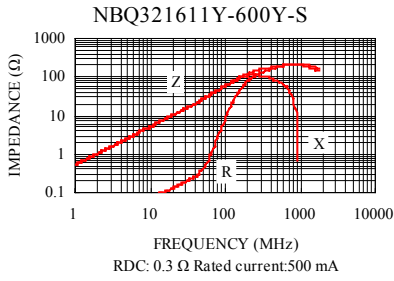

# MULTILAYER FERRITE CHIP BEADS

## Tape Dimensions

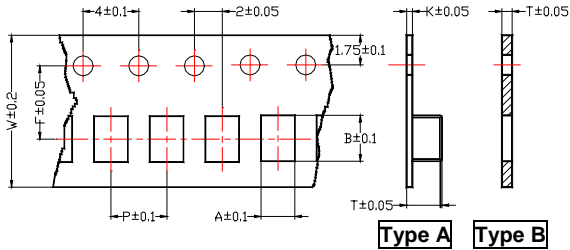

## Tape Material

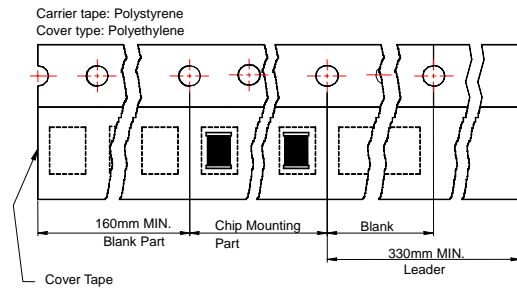

- ① : S/P/N    ② : S/P/U/N/G  
③ : S/G      ④ : S/P/G

## Reel Dimensions

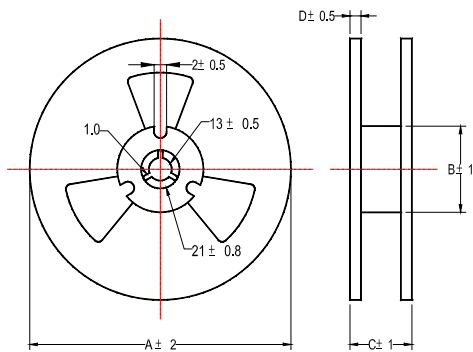

## Recommended Pattern

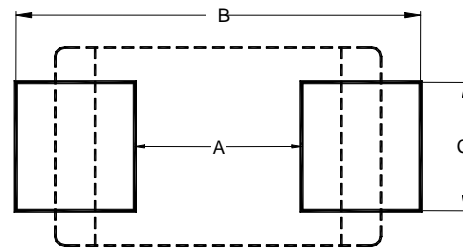

\* Don't apply narrower pattern than listed above to PBY.  
Narrow pattern might cause excessive heat or open circuit.

Dimensions in mm

TYPE	Tape Dimensions								Reel Dimensions				Recommended Pattern			Quantity /Reel
	A	B	T	W	P	F	K	TapeTyp.	A	B	C	D	A	B	C	
①B100505	0.62	1.15	0.7	8.0	2.0	3.5	-	B	178	60	10	2	0.4	1.2 ~ 1.4	0.4	10000
②B160808	1.05	1.80	0.95	8.0	4.0	3.5	-	B	178	60	10	2	0.8	2.4 ~ 3.4	0.6	4000
③B201209	1.42	2.30	1.05	8.0	4.0	3.5	0.2	A	178	60	10	2	1.2	3.0 ~ 4.0	1.0	4000
④B321611	1.88	3.50	1.27	8.0	4.0	3.5	0.2	A	178	60	10	2	2.0	4.2 ~ 5.2	1.2	3000
⑤B321616	1.88	3.64	1.90	8.0	4.0	3.5	0.2	A	178	60	10	2	2.0	4.2 ~ 5.2	1.2	2000
⑥B322513	2.77	3.42	1.65	8.0	4.0	3.5	0.2	A	178	60	10	2	2.0	5.5 ~ 6.5	1.8	2500
⑦B451616	1.88	4.95	1.90	12	4.0	5.5	0.3	A	178	60	14	2	3.0	5.5 ~ 6.5	1.2	2000
⑧B453215	3.66	4.95	1.85	12	8.0	5.5	0.3	A	178	60	14	2	3.0	5.5 ~ 6.5	2.4	1000



# MULTILAYER FERRITE CHIP BEADS ARRAY

## Tape Dimensions

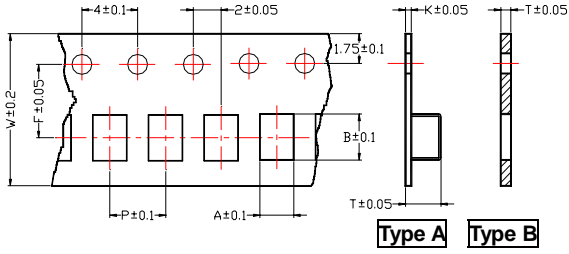

## Tape Material

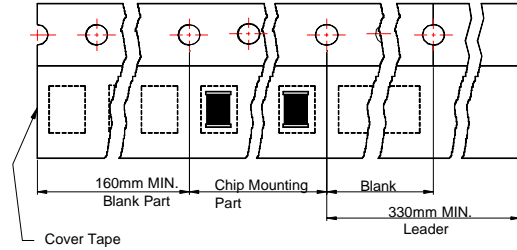

## Reel Dimensions

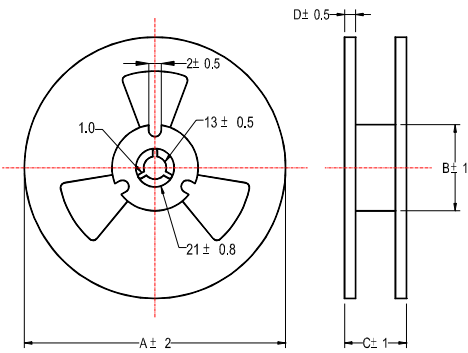

## Recommended Pattern

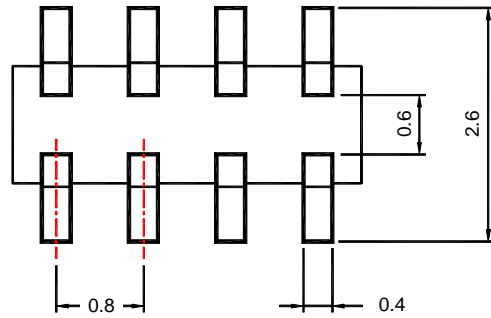

Dimensions in mm

TYPE	Tape Dimensions							Reel Dimensions				Quantity /Reel
	A	B	T	W	P	F	K	A	B	C	D	
B321609	1.94	3.54	1.29	8.0	4.0	3.5	0.2	178	60	10	2	3000



# MULTILAYER FERRITE CHIP BEADS ARRAY

## 1-1.Mechanical Performance

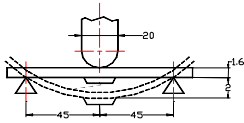
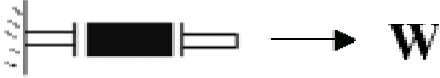
No	Item	Specification	Test Method
1-1-1	Flexure Strength		Test device shall be soldered on the substrate Substrate Dimension: 100x40x1.6mm Deflection: 2.0mm Keeping Time: 30sec *For 100505, substrate dimension is 100x40x0.8mm
1-1-2	Vibration	Appearance: No damage Z change: within±20% RDC: within specification	Test device shall be soldered on the substrate Oscillation Frequency: 10 to 55 to 10Hz for 1min Amplitude: 1.5mm Time: 2hrs for each axis (X, Y & Z), total 6hrs
1-1-3	Resistance to Soldering Heat	Appearance: No damage	Pre-heating: 150 , 1min Solder Composition: Sn/Pb = 63/37 Solder Temperature: 260±5 Immersion Time: 10±1sec
1-1-4	Solderability	The electrodes shall be at least 90% covered with new solder coating	Pre-heating: 150 , 1min Solder Composition: Sn/Pb = 63/37 Solder Temperature: 230±5 Immersion Time: 4±1sec
1-1-5	Terminal Strength Test	100505 series : 0.2 kg 160808 series : 0.5 kg 201209 series : 1.0 kg other series : 2.0 kg	Test device shall be soldered on the substrate 

# MULTILAYER FERRITE CHIP BEADS ARRAY

## 1-2.Environmental Performance

No	Item	Specification	Test Method															
Temperature Cycle	Appearance: No damage Z change: within $\pm 20\%$ RDC: within specification		One cycle: <table border="1"> <thead> <tr> <th>Step</th> <th>Temperature ( )</th> <th>Time (min)</th> </tr> </thead> <tbody> <tr> <td>1</td> <td>-55<math>\pm 3</math></td> <td>30</td> </tr> <tr> <td>2</td> <td>25<math>\pm 2</math></td> <td>3</td> </tr> <tr> <td>3</td> <td>125<math>\pm 3</math></td> <td>30</td> </tr> <tr> <td>4</td> <td>25<math>\pm 2</math></td> <td>3</td> </tr> </tbody> </table> Total: 100cycles Measured after exposure in the room condition for 24hrs	Step	Temperature ( )	Time (min)	1	-55 $\pm 3$	30	2	25 $\pm 2$	3	3	125 $\pm 3$	30	4	25 $\pm 2$	3
Step	Temperature ( )	Time (min)																
1	-55 $\pm 3$	30																
2	25 $\pm 2$	3																
3	125 $\pm 3$	30																
4	25 $\pm 2$	3																
1-2-2	Humidity Resistance		Temperature: 40 $\pm 2$ Relative Humidity: 90 ~ 95% Time: 1000hrs Measured after exposure in the room condition for 24hrs															
1-2-3	High Temperature Resistance		Temperature: 125 $\pm 3$ Relative Humidity: 0% Applied Current: Rated Current Time: 1000hrs Measured after exposure in the room condition for 24hrs															
1-2-4	Low Temperature Resistance		Temperature: -55 $\pm 3$ Relative Humidity: 0% Time: 1000hrs Measured after exposure in the room condition for 24hrs															

# SURFACE MOUNT TIP / RING FILTERS

## Tape Dimensions

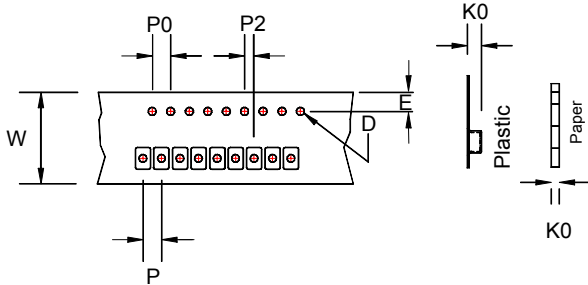

## Tape Material

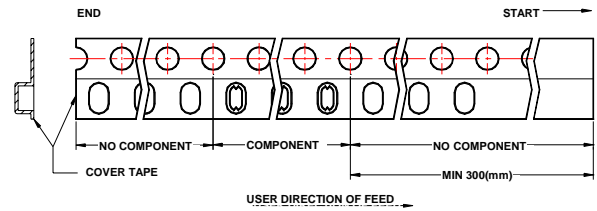

## Reel Dimensions

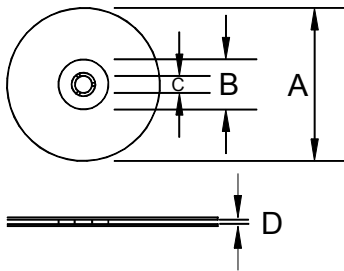

## Recommended Pattern

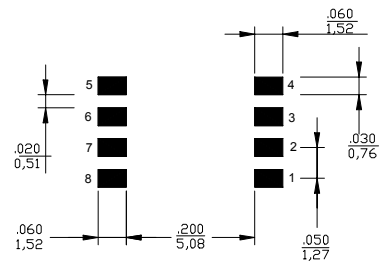

Dimensions in mm

TYPE	Tape Dimensions							Reel Dimensions				Quantity ( PCS / REEL )
	K0	D	E	W	P	P0	P2	A	B	C	D	330mm
CEC RF 2000	6	1.55	1.75	16	8	4	2	330	100	13	24.4	2200
CEC RF 4000	6	1.55	1.75	16	8	4	2	330	100	13	24.4	2200